

LINK

A MODULAR TABLE COLLECTION

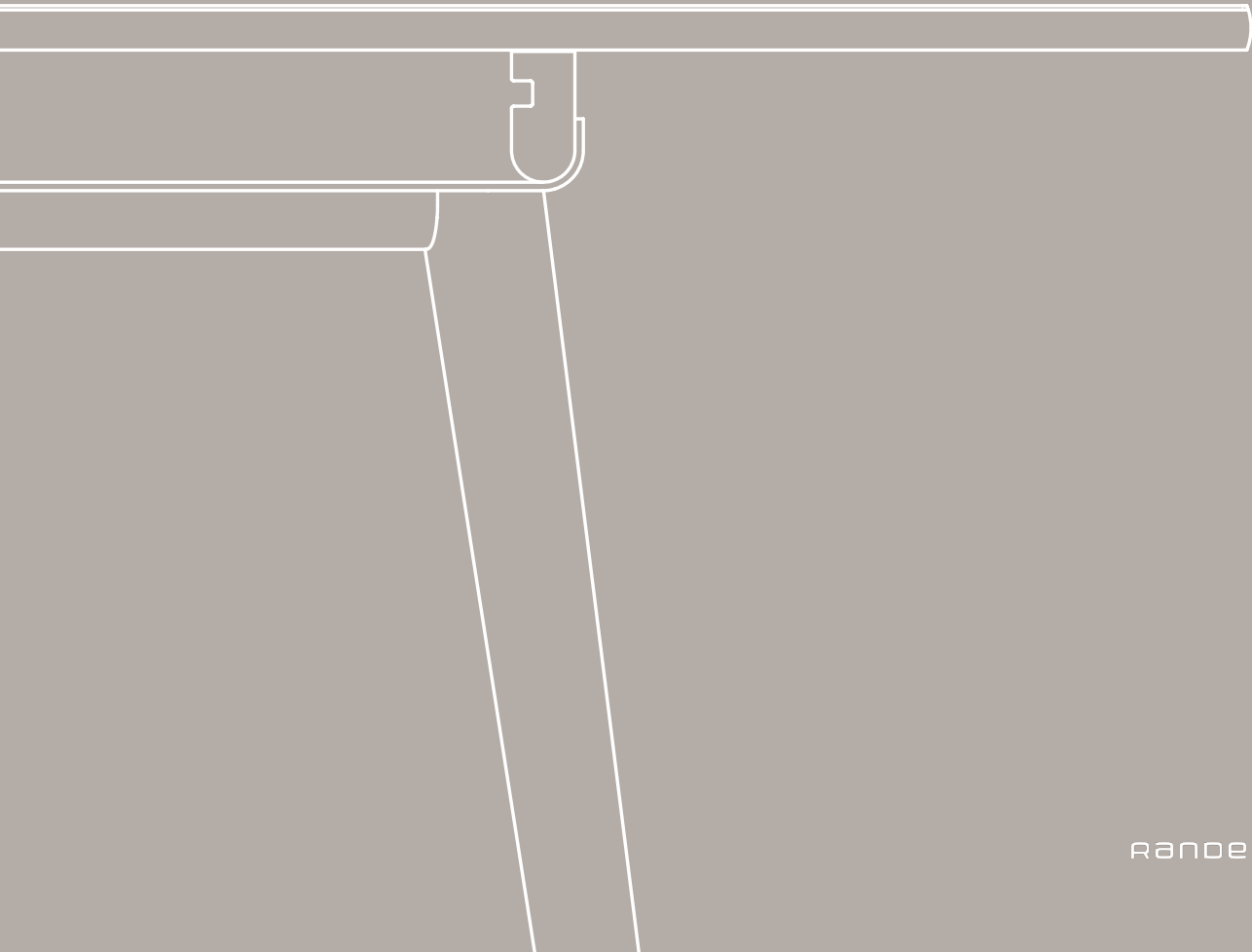

RANDERS + RADIUS

LINK

DESIGN BY HANS THYGE & CO

Link is a flexible and multi-functional table collection designed by Hans Thyge & Co. It's beautifully crafted and consists of a large series of modules which gives you the freedom to customize and create your meeting table, conference table or working space your way. The modules are available in many different shapes, sizes and colours and you can also get Link as a bar table.





INTELLIGENCE BELOW THE SURFACE

The solid wood slide rails below the table top allows you to easily change the leg position and to extend the table for extra seating space. By adding extra table tops in different sizes and shapes or accessories such as drawers, standing desks or metal trays, you can configure the table to your specific needs and at the same time change the aesthetic appearance of the table.



Link table size: 145x120 + 140x120 table top: Forbo linoleum 'Mauve' with tray, Tono Wood chairs.



FINE DETAILS & CAREFULLY CHOSEN DETAILS

Link tables consists of many beautiful and carefully chosen details, from the soft rounded solid oak edge on the table top, to the possibility to add accessories to the table. Link has an airy and elegant expression, which is emphasized by the simple leg construction that visually causes the linoleum table top to hover over the slightly sloped legs.

Link table collection



H: 73.5

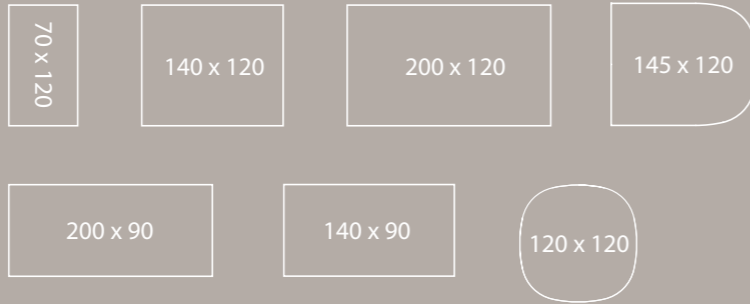

Link bar collection



H: 92



H: 105



Examples of combinations

Total length 350



Total length 285



Total length 340



Total length 280



Total length 290



Total length 360



Total length 480



Total length 570



Total length 400



Total length 490

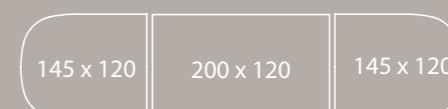



Link table size: 200x120 table top: Forbo linoleum 'Nero'. Tono Conference chairs.



Craftsmanship and silky smooth finish



Link bar table size: 200x70, H: 92 cm table top: Forbo linoleum 'Mushroom'. Mood bar chairs.



Link bar table size: 140x70, H: 105 cm. Table top: Forbo linoleum 'Charcoal'. Scope bar chairs.



The soft curved solid oak edge adds warmth and creates an elegant finish to the linoleum table top.



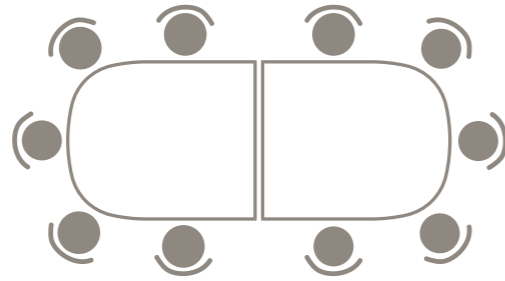

SEATING CAPACITY

How do you choose the right table size? The seating capacity chart helps you to find the right size. In the top left corner of each table, you can see the estimated number of seats. The number of seats depends on the size of the chair.

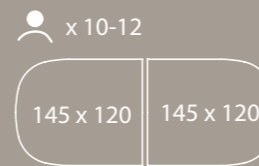
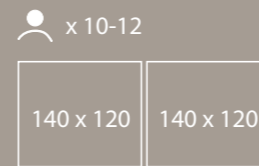
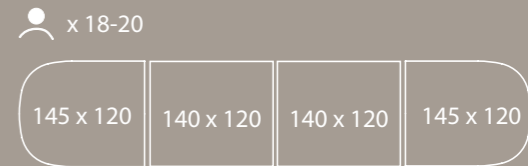
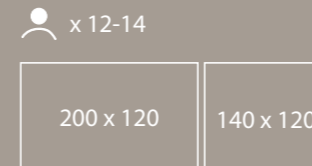
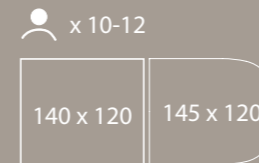
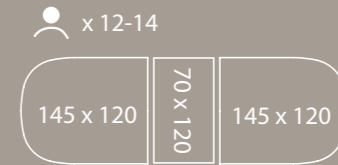
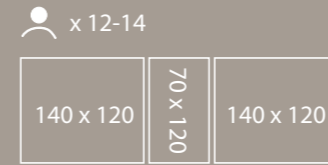



Link table size: 200x120 + 200x120 table top: Forbo linoleum 'Mushroom'. Mood Conference chairs.

"A nice table needs to be both "invisible" and have interesting details that attracts your attention. The Link table has fine proportions, it's simple and minimalistic with aesthetics and intelligence features below the surface".

- Hans Thyge



Link table size: Ø120. Table top: Forbo linoleum 'Mauve'. Tono Conference chairs.



Link table size: Ø120 table top: Forbo linoleum 'Iron'. Mood Classic chairs.



Link table Ø120 with soft curved edges and legs in solid oak. Table top in black linoleum combined with Dry arm chairs in Terracotta.



ACCESSORIES

Tailor your Link table design with accessories. Choose between the solid wood oak drawer, metal tray, standing desk or the integrated powerbox.

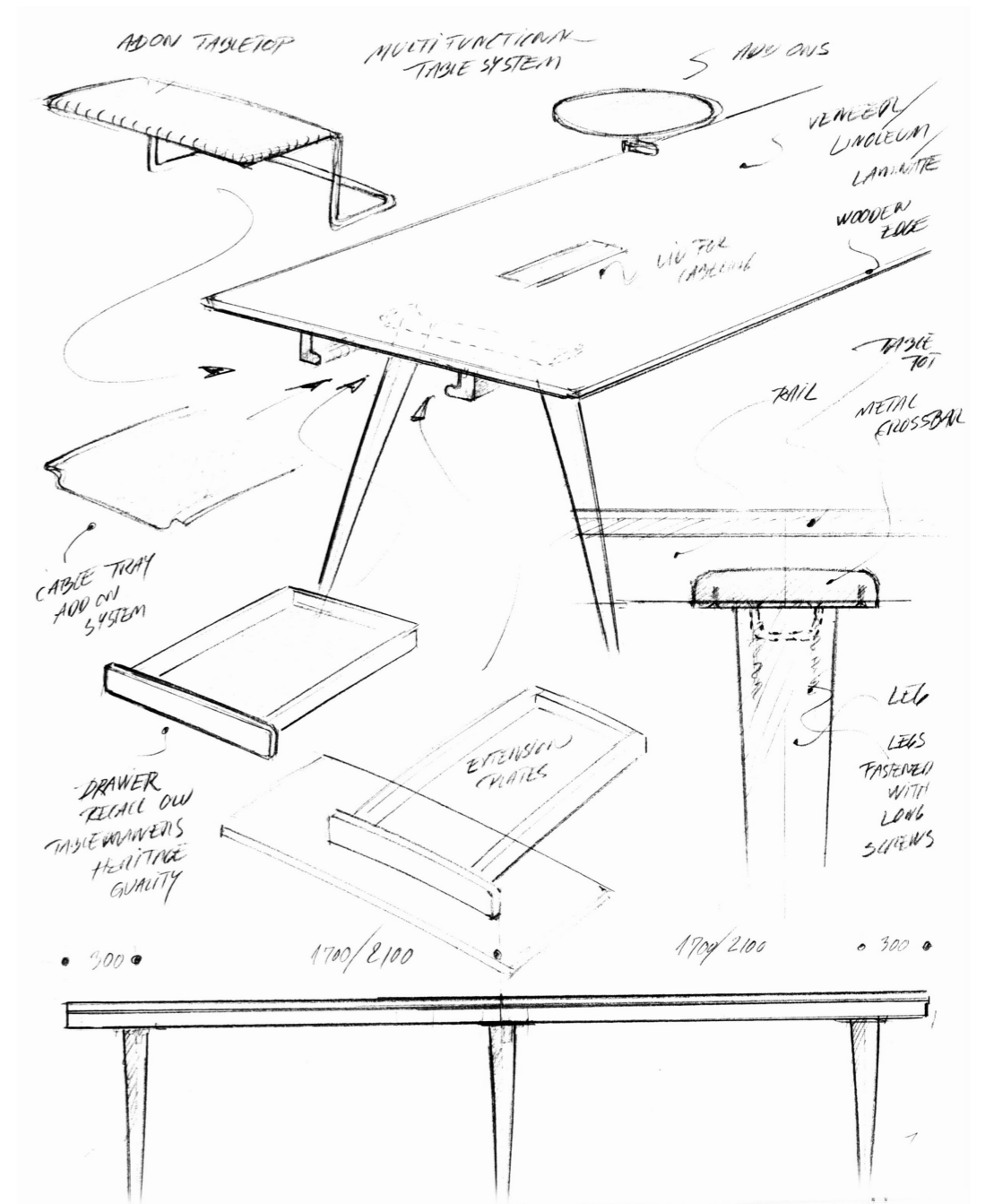



26

Link table size: 145x120 + 140x120 table top: Forbo linoleum 'Mauve' with tray. Tono Wood chairs.

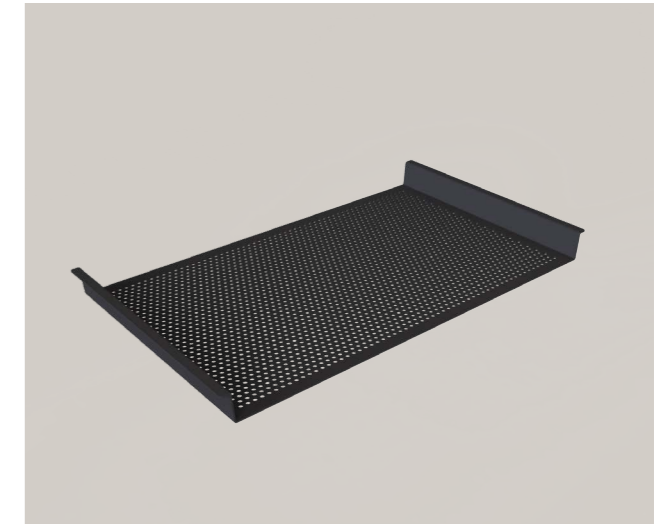

TRAY

Tray in powder coated perforated steel, that easily slides in between the solid wood slide rails. Can act both as storage for cables under the table top, as well as a small shelf.



STANDING DESK

Standing desk in powder coated steel. Can easily be slid in between the solid wood rails in both ends of the tables.



DRAWER

Stylish storage option made of solid wood. 32 cm deep and supplied fully assembled. The drawer elegantly finishes the oak construction hidden under the table top. It can be added in both ends of the Link tables.



POWERBOX

Add a powerbox to your table top and charge your devices. The powerbox is available in elegant matt black finish.



Link table size: 140x120 table top: Forbo linoleum 'Iron' with integrated powerbox and solid wood drawer. Mood Conference chairs.

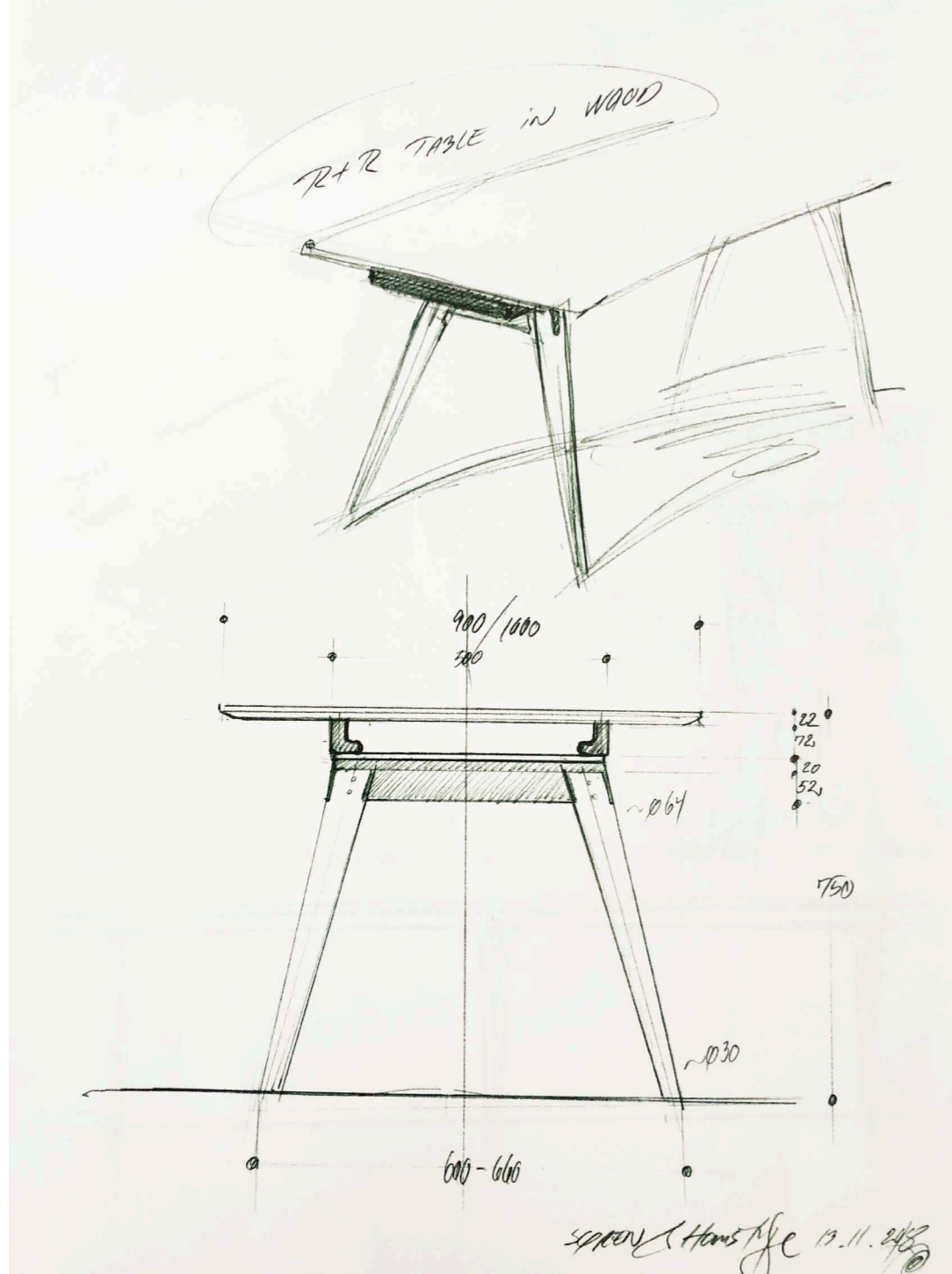

ABOUT HANS THYGE & CO.

Hans Thyge & Co design studio was founded in 1990 by Hans Thyge Raunkjaer. The studio consists of passionate designers with bold ideas and a love for beautiful design. The studio believes that every design should tell a story of creativity, tradition, vision, culture and values. The studio has received several awards throughout the years in the international design scene.

RANDERS+RADIUS

Randers+Radius A/S is a Danish manufacturer of innovative and timeless furniture, which is produced at our own factory in Hadsten, Denmark. We collaborate with some of Denmark's most talented and established architects and together we challenge form and materials.

Randers+Radius was founded in 2012, when the two Danish furniture manufactures R. Randers and Radius merged and hereby created a synergy of combined 60 years of experience in making high quality designer furniture.

RANDERS+RADIUS A/S

Tolsagervej 9

DK 8370 Hadsten

Tel. +45 7030 0515

info@randersradius.dk

www.randersradius.dk

